

50.0 A Single-Phase Silicon Bridge Rectifier
Rectifier Reverse Voltage 50 to 1000V

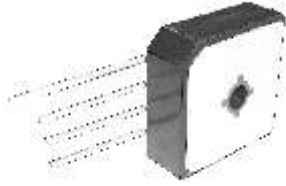

Features

- This series is UL listed under the Recognized Component Index, file number E142814
- Single In-Line terminals array suitable for P.C. board mounting
- Surge overload ratings to 400 amperes
- The plastic material used carries Underwriters Laboratory flammability recognition 94V-0
- Integrally molded heat sinks provide low thermal resistance for maximum heat dissipation
- High temperature soldering guaranteed 265°C /10 seconds at 5 lbs (2.3kg) tension

Mechanical Data

Case: Molded plastic with heat sink integrally mounted in the bridge encapsulation
 Terminals: Plated wire leads solderable per MIL-STD-202, Method 208
 Mounting Position: Any
 Weight: 0.6 ounce, 17 grams (approx)

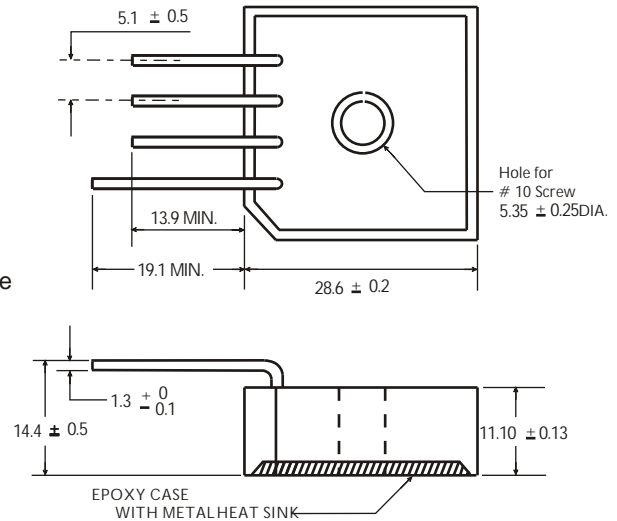

Dimensions in millimeters (1mm=0.0394")

Maximum Ratings & Thermal Characteristics

Rating at 25°C ambient temperature unless otherwise specified, Resistive or Inductive load, 60 Hz.
 For Capacitive load derate current by 20%.

Parameter	Symbol	MP	MP	MP	MP	MP	MP	MP	Unit
		50005S	5001S	5002S	5004S	5006S	5008S	5010S	
Maximum repetitive peak reverse voltage	VRRM	50	100	200	400	600	800	1000	V
Maximum RMS bridge input voltage	VRMS	35	70	140	280	420	560	700	v
Maximum DC blocking voltage	VDC	50	100	200	400	600	800	1000	v
Maximum average forward rectified output current at TA=55°C	IF(AV)	50							A
Peak forward surge current single sine-wave superimposed on rated load (JEDEC Method)	IFSM	400							A
Rating for fusing (t<8.3ms)	I ² t	664							A ² sec
Typical thermal resistance per element(1)	ReJA	2.0							°C/ W
Operating junction and storage temperature range	TJ, TSTG	-55 to + 150							°C

Electrical Characteristics

Rating at 25°C ambient temperature unless otherwise specified. Resistive or Inductive load, 60Hz.
 For Capacitive load derate by 20 %.

Parameter	Symbol	MP	MP	MP	MP	MP	MP	MP	Unit
		50005S	5001S	5002S	5004S	5006S	5008S	5010S	
Maximum instantaneous forward voltage drop per leg at 25.0A	VF	1.0							V
Maximum DC reverse current at rated TA =25°C DC blocking voltage per element TA =125°C	IR	10 500							μA

Notes: (1)Thermal resistance from Junction to Ambient on P.C.board mounting.

Rating and Characteristic Curves ($T_A=25^{\circ}\text{C}$ Unless otherwise noted) MP50005S thru MP5010S

Fig. 1 Derating Curve for Output Rectified Current

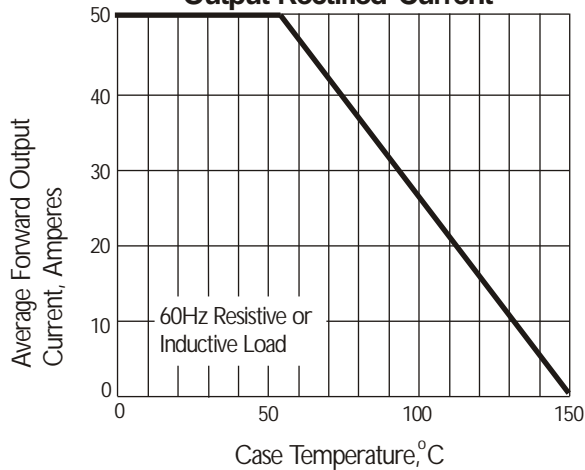

Fig. 2 Maximum Non-repetitive Peak Forward Surge Current

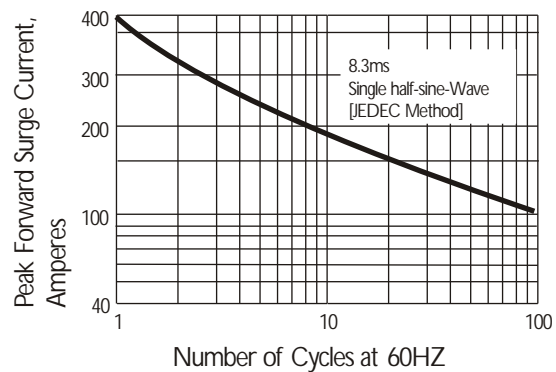

Fig. 3 Typical Instantaneous Forward Characteristics

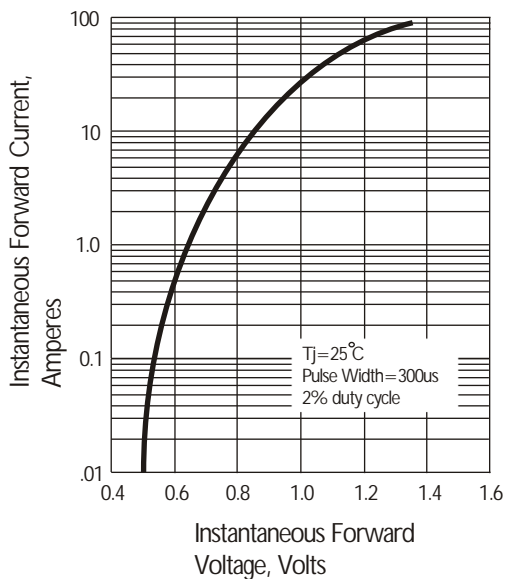

Fig. 4 Typical Reverse Characteristics at $T_J=25^{\circ}\text{C}$

